

1 **Undertaking Request (U-71)**

2

3 *Transcript Reference: July 25, 2018, Pg. 57, line 18 to Pg. 61, line 6*

4 *Re: Undertaking #54*

5 Undertake to confirm the role of the independent engineer and how far back they were
6 assigned/how long they have been in place.

7

8

9 **Undertaking Response**

10 Please refer to U-71, Attachment 1, pages 41-63.

Muskkrat Falls Project

Independent Engineer Report & Project Overview

April 15, 2014

Boundless Energy



Take a Moment for Safety

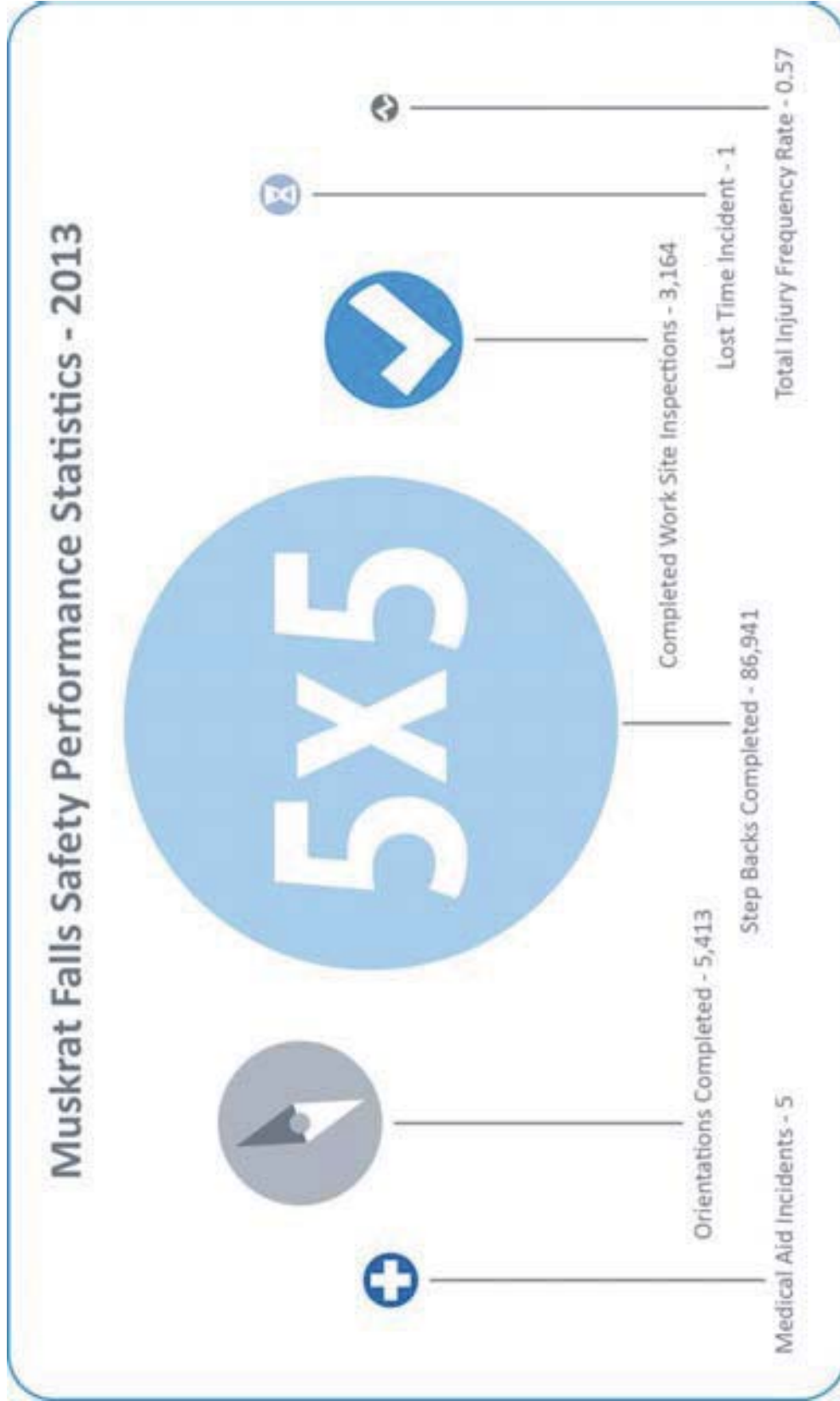

Outline

1. Muskrat Falls Project Update
2. Nalcor/Project Oversight
3. Government of Canada (GOC) Due Diligence
4. Selection of the Independent Engineer (IE)
5. Role of the Independent Engineer
6. IE's Scope of Work for Muskrat Falls Project
7. Overview of IE's Comments

Muskrat Falls Project Update

Global Reach

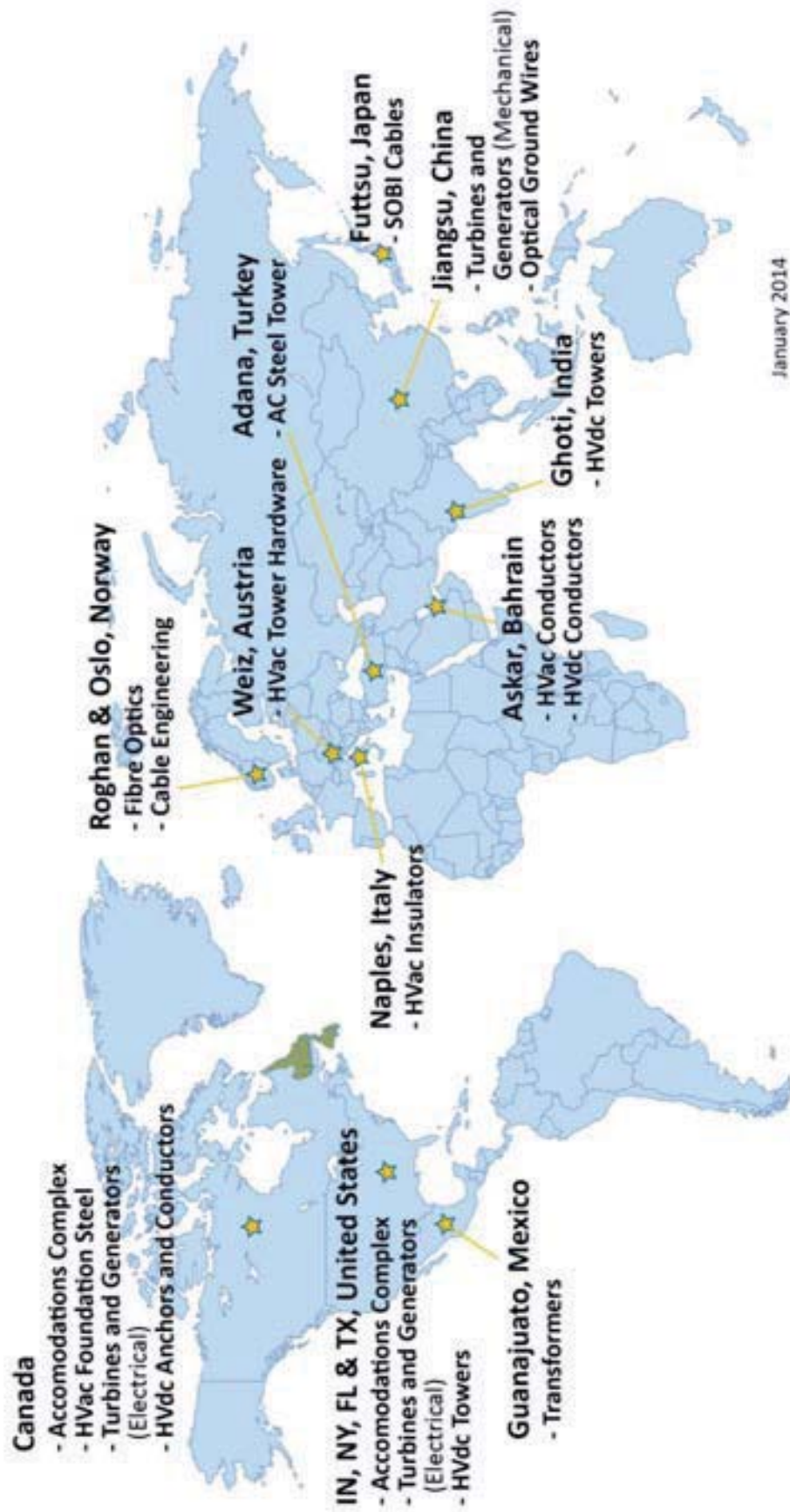

January 2014



LOWER CHURCHILL PROJECT

Key Milestones Achieved in 2013

- Federal Loan Guarantee and project financing completed
- EA approval for transmission
- Engineering >98% completed
- RCC cofferdam completed
- Bulk excavation completed
- Started horizontal directional drilling in Straits
- Starter camp opened; permanent camp under construction

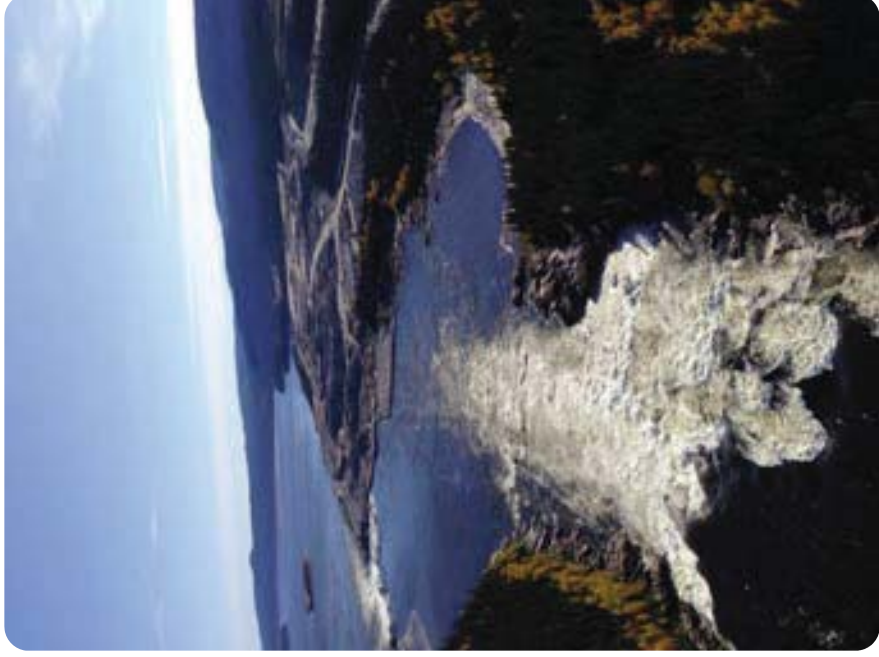

Key Milestones Achieved (2013)

- HVac transmission clearing started
- Marshalling yard constructed
- Structural testing on Hvac towers
- Civil work in Forteau & Churchill Falls started
- Astaldi started mobilization
- Historic Resources Recovery program ongoing



Muskrat Falls Site Key Activities

Key Project Activities – 2014

- Continue relentless commitment to safety
- Activity will ramp up in all areas of the project
- Employment is expected to reach approx. 2,500 by the end of 2014
- Priority activities:
 - Concrete placement in spillway and powerhouse
 - Begin tower assembly on HVac transmission line
 - Continue reservoir clearing
 - Award final major contracts

Muskrat Falls Generating Facility

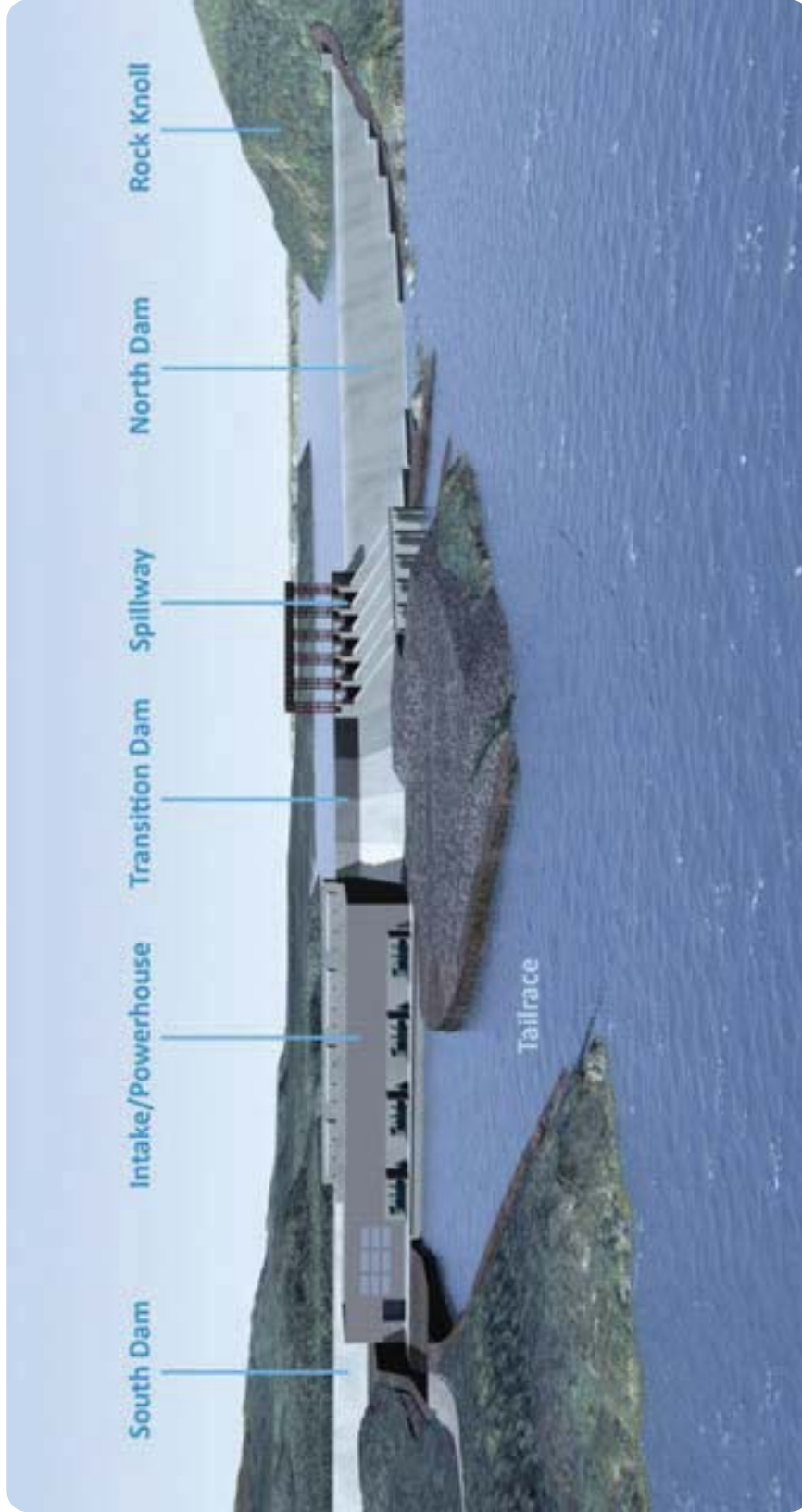

LOWER CHURCHILL PROJECT



Powerhouse Excavation – Sept 2013



Riverside Cofferdam



Spillway Excavation



Intake for Powerhouse



Powerhouse/Spillway Area



Powerhouse – Astaldi Start-up



Accommodations Complex (Starter and Permanent)



Preparing spillway for first slab pour



Powerhouse Cross Section

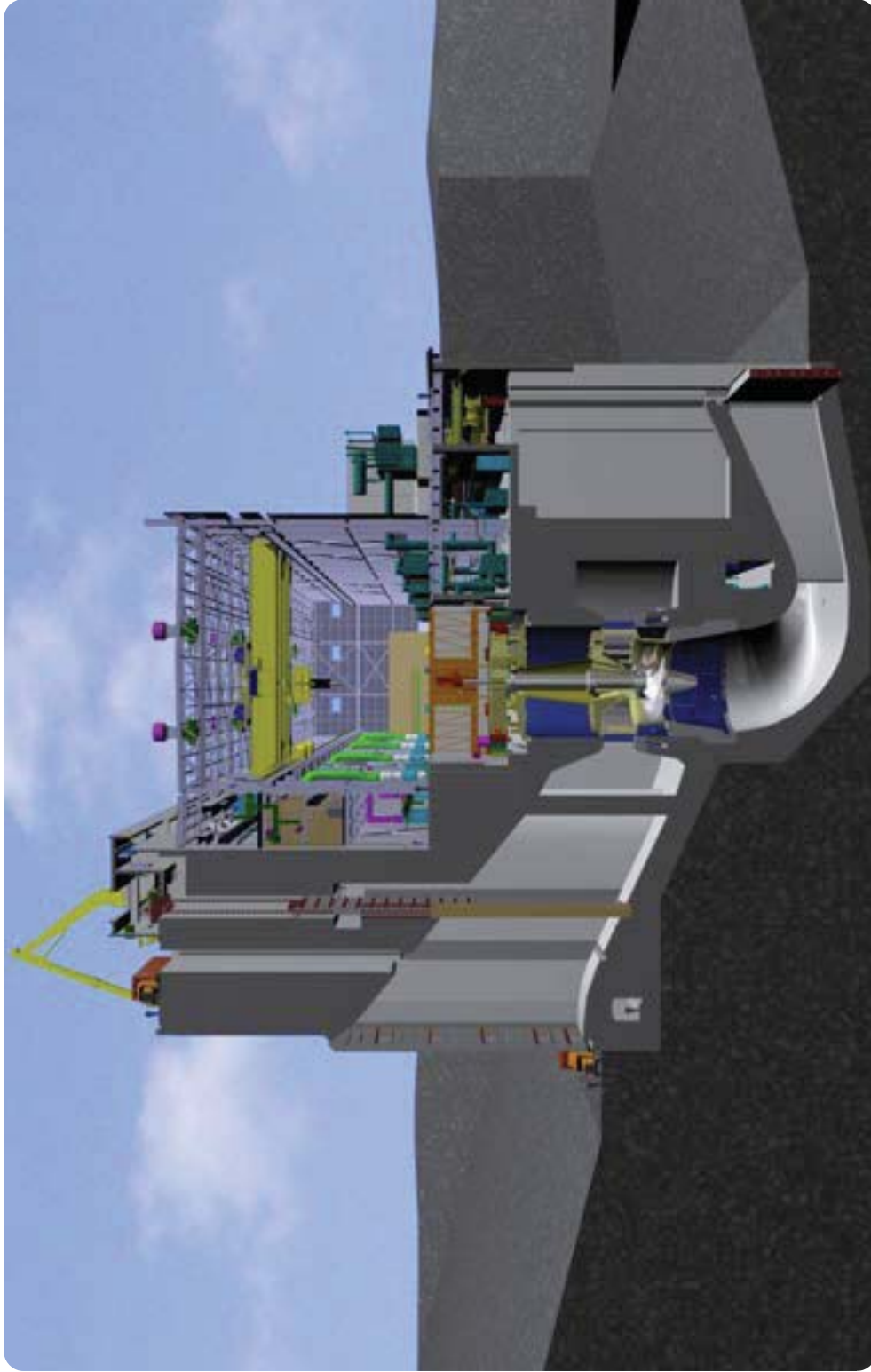

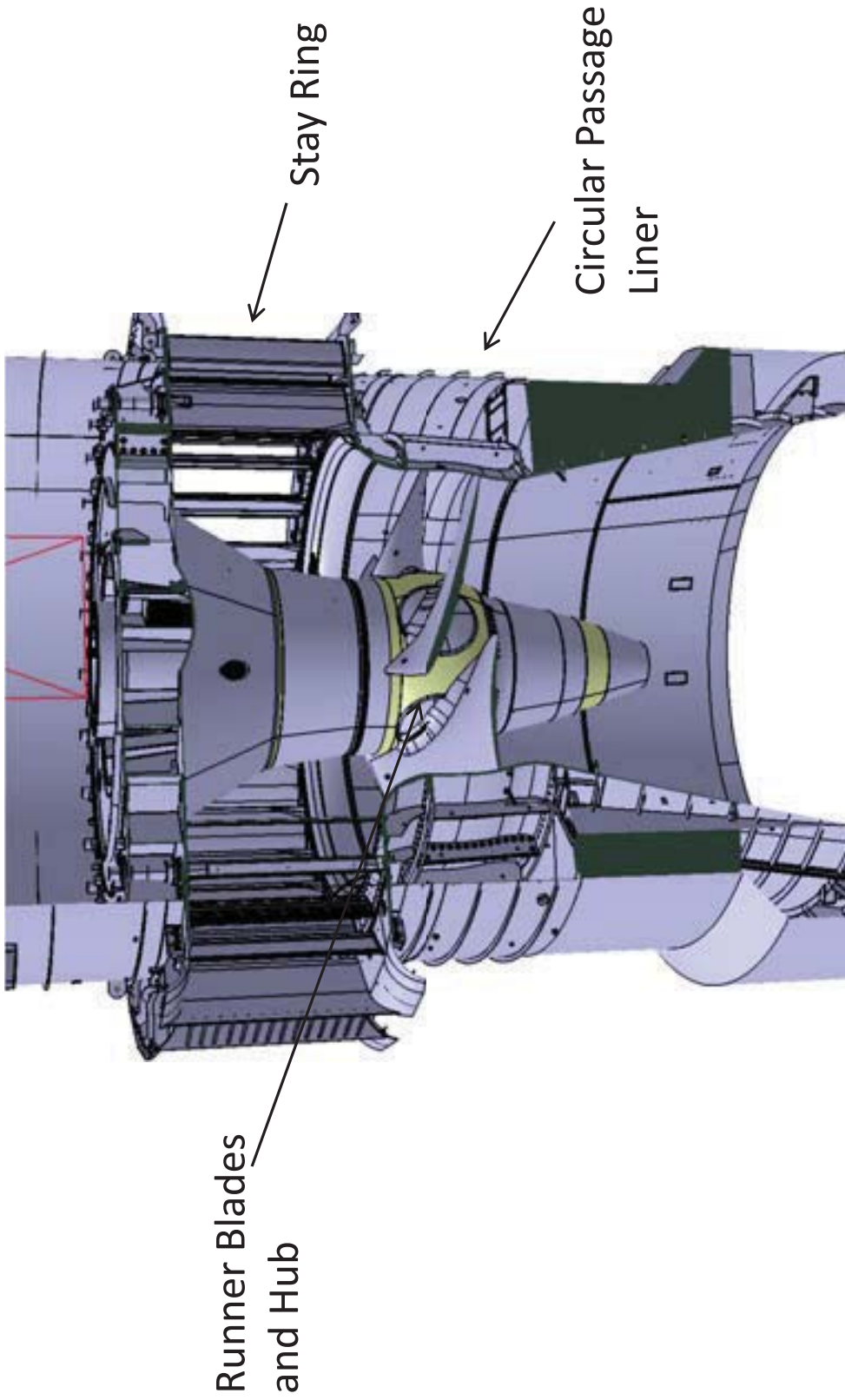

Erzhong, China – Runner Hubs

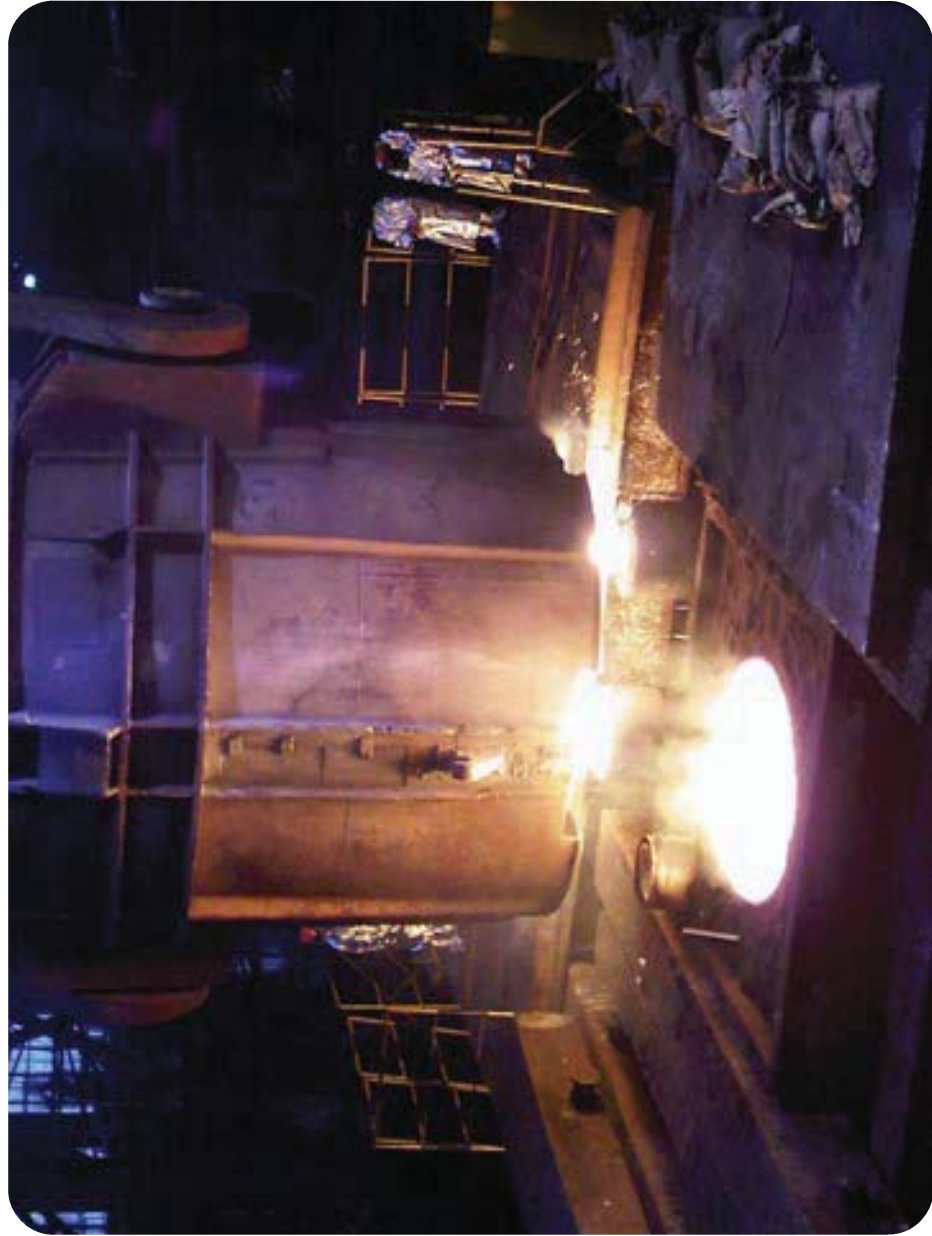

LOWER CHURCHILL PROJECT



Hub – Rough Machining



Runner Blades



Transmission Key Activities



Key Activities – HVac Transmission

- Continue with right of way clearing in advance of transmission construction
- Begin transmission construction from Muskrat Falls to Churchill Falls

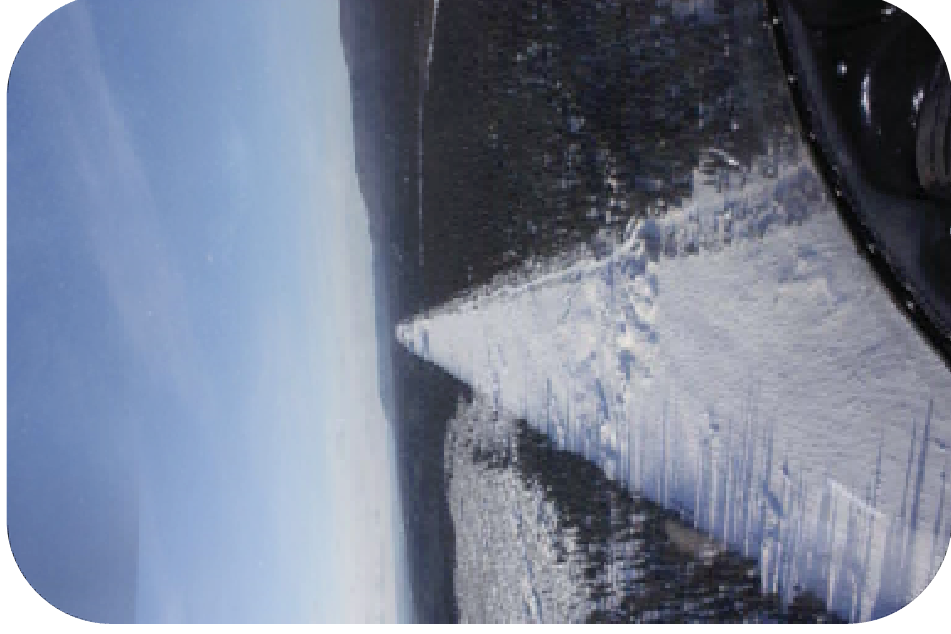

Key Activities – HVdc Transmission

- Award transmission construction contract & start construction:
- Conclude Churchill Falls and Muskrat Falls Switchyard site preparation. Work begins at these sites in Q3
- Begin site preparation and development at Soldiers Pond and electrode sites
- Award contracts for Synchronous Condensers, Converters and Switchyard & begin all site work

Muskrat Falls Converter/Switchyard Area

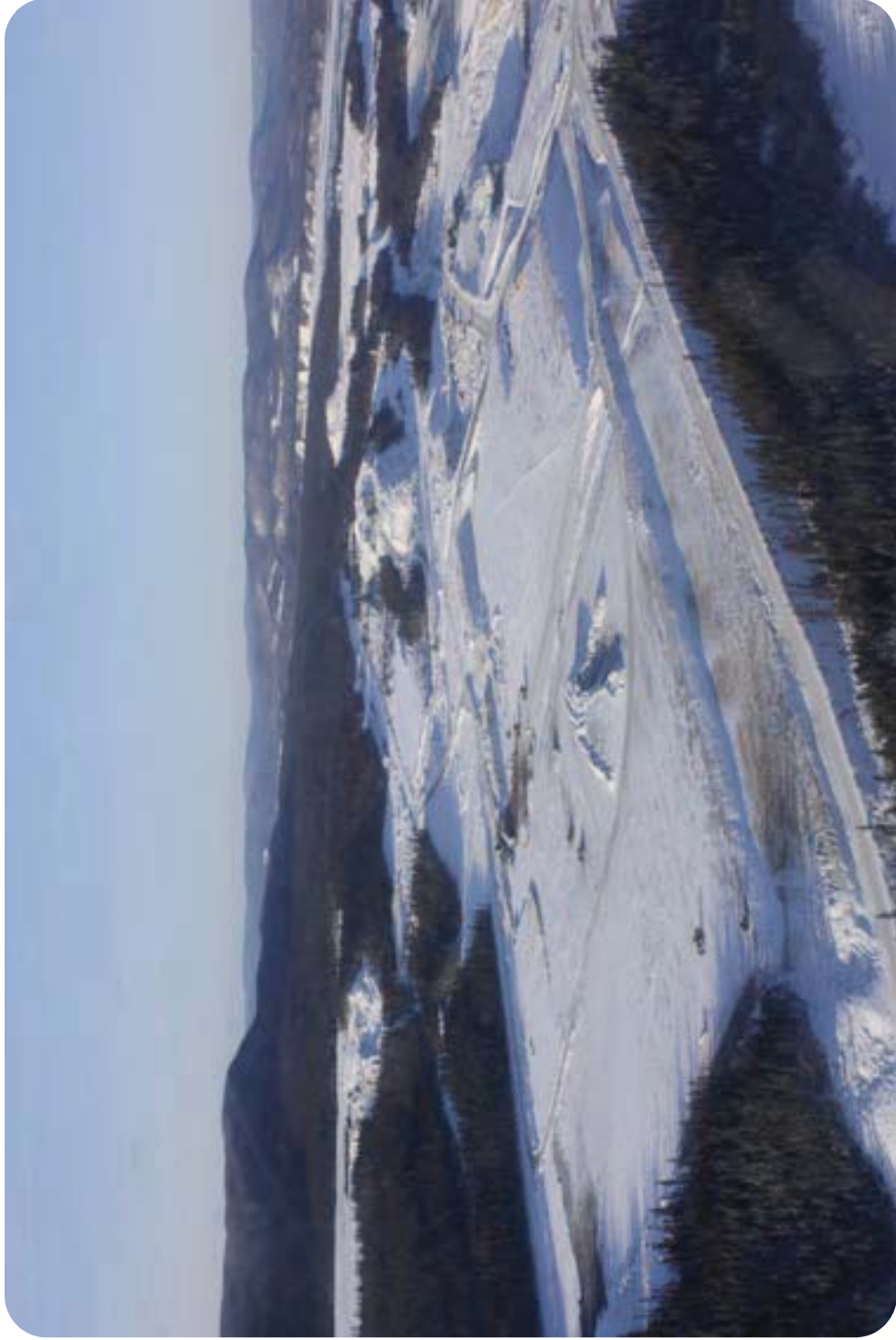

Churchill Falls Switchyard Area



HVAc Towers

Self supporting structures



Guyed Structures



HDD Drill Rig - Strait of Belle Isle



Cable manufacturing, Japan

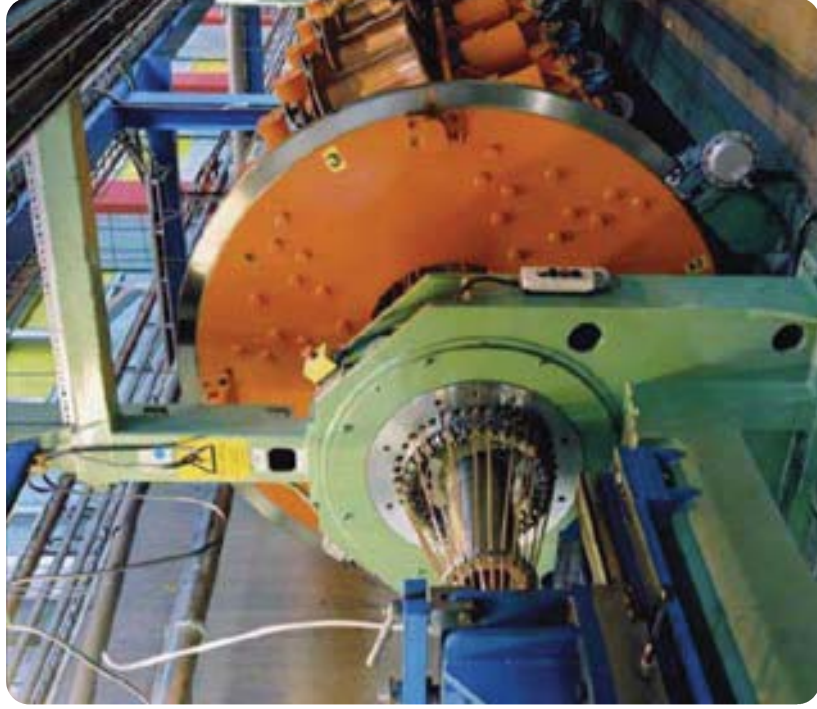
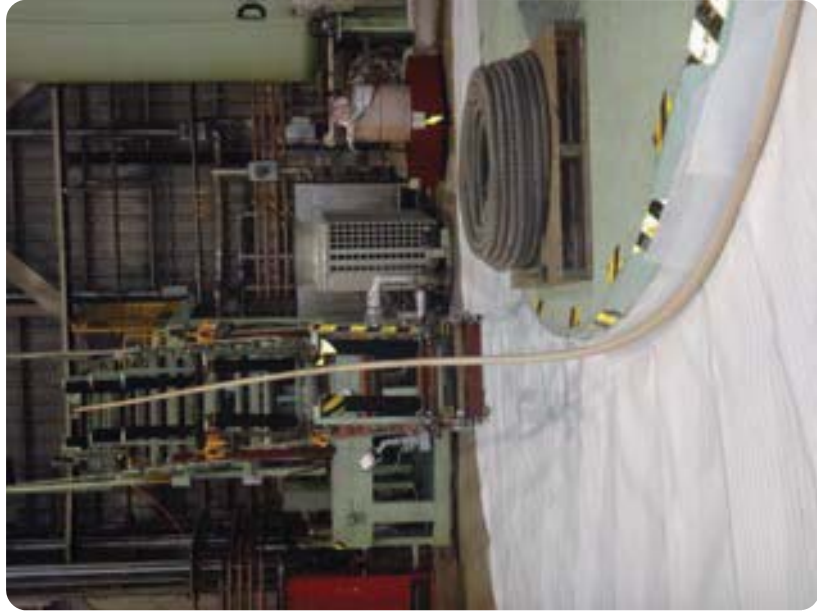

Production of Submarine Cable



Stranding 2



Stranding 3



Paper Lapping



LOWER CHURCHILL PROJECT

Drying & Impregnation Vessel



Nalcor/Project Oversight



Nalcor/Project Oversight

- Government of NL (GNL), on behalf of the people of the province, holds Nalcor accountable for project management and establishing oversight practices and procedures
- Nalcor reports to the public and GNL through:
 - annual reports and audited financial statements
 - public AGM
 - requests for information, open houses & presentations
- Monthly Muskrat Falls Project public reports
- Nalcor will begin quarterly reporting
- Nalcor presents its capital and operating budgets to GNL for review and approval

Internal Approach & Oversight

- Best practice project management processes
- Internal audit
- Internal quality control
- Board of Directors of project subsidiaries providing oversight and governance

Government of NL Oversight

- Muskrat Falls Oversight Committee to strengthen and formalize the existing oversight for the construction phase of the project
- Additional special project audit to be completed by Nalcor's financial auditors
- Independent engineer's oversight will be part of GNL Oversight
- Auditor General has open access to Nalcor

Government of Canada Due Diligence & Oversight

- Comprehensive approach supported by:
 1. External Legal Advisors
 2. Financial Advisors
 3. Independent Engineer
 4. Independent Insurance Consultant
- Due diligence supported federal Loan guarantee (FLG) for \$5B in November 2013

Overview of Independent Engineer

Selection of Independent Engineer (IE)

- MWH Canada was selected as IE in Aug'12 through a competitive process
- MWH was engaged to represent Government of Canada in its capacity as guarantor
- MWH Global, Inc:
 - headquartered in Colorado, 8,000 employees, 180 offices in 35 countries
 - involved in: hydropower, dams, oil and gas, power delivery, and clean energy and sustainability

Role of the Independent Engineer

- One component of GOC's comprehensive due diligence of the project is to provide ongoing oversight as part of the federal loan guarantee and financing arrangements
- MWH will provide regular progress reports which will also form part of the GNL oversight of the project
- This role is standard practice for lenders when financing projects of this nature

Role of the Independent Engineer

- A three-phase approach was established for the IE's scope of work:
 - Phase 1 - pre-financial close
 - Phase 2 - financial close (Dec 2013) through project construction until commissioning
 - Phase 3 - operations, maintenance and monitoring following commissioning until the guaranteed debt is fully repaid

IE Scope of Work – Phase 1

- Review of:
 1. Project design and projected performance
 2. Construction plan and schedule
 3. Capital budget
 4. Commercial operation
 5. Project agreements
- Muskrat Falls site visit

IE Ongoing Scope of Work - Phase 2

- MWH will:
 1. attend project review meetings
 2. monitor engineering and procurement against milestone schedules
 3. conduct site visits
 4. review quality control documents to assess compliance with milestone schedules
 5. prepare periodic and final reports
 6. verify project completion

IE Scope of Work - Phase 3 (post commissioning)

- MWH to provide ongoing monitoring following commissioning to ensure the assets are being operated and maintained in accordance with good utility practice

Independent Engineer Report Overview

Key Areas of Focus

1. Site Visit
2. Project Design and Projected Performance
3. Construction Plan and Schedule
4. Capital Budget
5. Commercial Operation and Maintenance
6. Project Agreements
7. Review Permits and Licenses
8. Financial Pro Forma

1. Site Visit

- Site visit and the work performed to date was considered of high standard
- Work on cofferdams are satisfactory
- Blasting quality on powerhouse exceeds normal practice
- Site camps and infrastructure appear to be adequate for planned construction works

2. Project Design & Projected Performance

- Experience and capability of the project team, consultants and major contractors is viewed as positive
 - “In our opinion, and based on past experience, the Integrated Project Team...are qualified to design, contract, manage, commission, operate and maintain the three projects currently under design and construction for the LCP.”

2. Project Design & Projected Performance

- “The Muskrat Falls Generating site is a relatively easy site to develop from a technical and logistical point of view.”
- Hydrological risk is well understood and satisfactorily studied

2. Project Design & Projected Performance

- North Spur:
- “The stabilization works have been designed in accordance with currently accepted geotechnical practices and will effectively stabilize the north spur when the reservoir is impounded.”
 - “Recommended additional studies [which Nalcor had initiated] on the sensitive clays will be useful to confirm current design assumptions, but should not significantly affect the current design scheme.”

3. Construction Plan & Schedule

- Integrated Project Team model is considered a key enabler to project success:
 - “The organizational model shift is viewed as a key enabler of team effectiveness, which is considered imperative for delivery of this megaproject.”
- In reference to the powerhouse contractor:
 - “The IE has evaluated the qualifications of Astaldi in terms of their capability to perform...with respect to quality, schedule and budget and finds they have the capacity to perform adequately.”

3. Construction Plan & Schedule

- Probability that Nalcor's projects' schedule objectives can be achieved. Target in-service dates remain under pressure
- The use of the mega dome by Astaldi is a positive mitigation against weather risk which could impact schedule
- MWH (and LCP) recognized that not all contracts were awarded yet and therefore schedules could not be incorporated into the integrated schedule and critical path

4. Capital Budget

- IE assessed facilities capital and operating costs, not financing costs
- DG3 (sanction) estimate was developed following “good utility practice” and “robustly prepared”
- Escalation is a realistic estimate
- DG3 (sanction) capital cost contingency is considered to be at low end of observed range and aggressive relative to the IE’s experience and IE would advocate for adjustment of project contingency fund

4. Capital Budget

- MWH found the DG3 (sanction) estimate to be within the range of an AACEI Class 3 Estimate: -20% to +30%
- Engineering definition is a major determinant to estimate accuracy
- Class 3 estimate accuracy can be as high as -10% /+10% with high levels of definition
- Estimate accuracy increases with pricing from procurement process, and current definition is higher than November 2013
- With completion of procurement, contract data will be available, at which time an AACEI Class 2 estimate will be prepared

5. Commercial Operation & Maintenance

- In reference to reliability:
 - “ ...the expected performance of Nalcor, and the companies it has established to operate and maintain the LCP assets, is expected to be at least as reliable as the CEA average and is satisfactory.”
 - “ ...we find Nalcor's overall performance exceeds the [North American Electric Reliability Corporation's] NAERC averages for the period compared [2006-10].”

5. Commercial Operation & Maintenance

- Operating and maintenance estimate costs are considered below the normal annual costs compared to other large hydro plants

6. Project Agreements

- Water Management Agreement is similar to other agreements and is found to be satisfactory

7. Review Permits and Licenses

- As part of MWH's review of permits and licenses, they reviewed the Project-Wide Environmental Protection Plan. “In the opinion of the IE, the Plan, itself, is comprehensive and suitable, and is judged to be satisfactory for the LCP.”

8. Financial Pro Forma

- Nalcor's financial planning pro forma models are comprehensive

Report release

- Report is posted on the Muskrat Falls Project website: www.muskratfalls.nalcorenergy.com
- Release of report done in coordination and with permission of GOC and MWH
- Report is released with redactions for commercially-sensitive information to ensure Nalcor maintains value for customers and its shareholder
- Once information no longer commercially sensitive, redactions will be removed

Sharing our ideas in an open and supportive manner to achieve excellence.

Teamwork

Open Communication

Fostering an environment where information moves freely in a timely manner.

Honesty and Trust

Being sincere in everything we say and do.

Relentless commitment to protecting ourselves, our colleagues, and our community.

Safety

Respect and Dignity

Appreciating the individuality of others by our words and actions.

Leadership

Empowering individuals to help, guide and inspire others.

Holding ourselves responsible for our actions and performance.

Accountability

LOWER CHURCHILL PROJECT

